

GOYO

色标传感器

Color Sensors



CE

光洋高品质、高标准产品
为客户提供全方位服务



BZJ系列



KS系列



Z3N系列

温州市光洋工业自动化有限公司
Wenzhou Guangyang Industrial Automation CO., LTD.

色标传感器常用于检测特定色标或物体上的斑点，它通过与非色标区相比较来实现色标检测，而不是直接测量颜色。色标传感器是一种双透镜系统，受光器接收到由投影机发出被检测物表面漫反射光而引起动作来进行检测。

注：电位器旋转角度为270°，须按箭头标识旋转，直至不动为止，切不可强行再转。

Color sensors use in detection the specific mark or the color point on the object surface. It is through comparison of non-color areas to achieve the color detection, but not detect the color in directly. Color sensor is a system with double lens, it works via detect the light from the emitter what after the reflected by the object surface.

Note: Potentiometer wiring angle is 270°, user turn it need accord to arrow logo. When it can not move, the user must not turn it anymore.

色标传感器 Color Sensors

- 多种电路保护措施，确保产品稳定安全使用：逆极性保护、浪涌保护、短路保护
- 清晰明确的指示方式：红色LED显示可检查传感器的状态
- 选用优良元器件和严格生产品控流程，保证产品的长寿命和高可靠性
- 使用成本经济，操作简易，运用广泛
- Various of circuit protection ensure the production was to be used in safety and stably: Reverse polarity protection, surge protection and short-circuit protection.
- Clearly instruction method: red LED showed the sensor detect status.
- With excellent components and strictly production control process ensure all of production have a long life and high reliability.
- Economy cost, easy operate and widely using.

记号传感器(检测色感·明暗)

根据可判别彩色记号的颜色来选择色标传感器识别色与光源：

Color sensors (Detect color · Light and dark), Depend on the color which could distinguish color select the mark, sensor to distinguish the color and light source:

○ 白色光源 White light ● 红色光源 Red light ● 绿色光源 Green light ● 蓝色光源 Blue light

底色 Background 标识色 Marking color	白 White	黄 Yellow	橙 Orange	红 Red	绿 Green	蓝 Blue	黑 Black
白 White	—	○●	○●●	○●●	○●●●	○●●●	○●●●
黄 Yellow	○●	—	○●	○●	○●●	○●●●	○●●●
橙 Orange	○●●	○●	—	○●	○●●	○●●	○●●
红 Red	○●●	○●	○●	—	○●●	○●●●	○●●
绿 Green	○●●●	○●●	○●●	○●●	—	●	○●●
蓝 Blue	○●●●	○●●●	○●●	○●●●	●	—	○●●
黑 Black	○●●●	○●●●	○●●	○●●	○●●	○●●	—

在单色光源中，绿光LED（565nm）和红光LED（660nm）各有所长，绿光LED比白炽灯寿命长，并且在很宽的颜色范围内比红光源灵敏度，红光LED对有限的颜色组合有响应，但它的检测距离比绿光LED远，通常红光源传感器的检测距离是绿光源传感器的6~8倍

In the monochromatic light source, green LED (565nm) and red LED (660nm) have their own strengths, green LED have a long life then incandescent, and have a higher sensitivity than red light source in a widely range. Red LED have responses with few color combine only, but it have a longer detection distance than green LED, Red light source detection distance is 6~8 times of green light.

色标传感器广泛应用于印刷、包装设备中进行辨别颜色、检测色标，可与其它设备一起使用；实现自动定位、定长、辨色、分切、纠偏、计数等功能。

Color sensors widely used in the printing, packing equipment, achieved to distinguish colors, detection the mark. Otherwise, it is work together with other device in order to achieve automatic positioning, length, color vision, cutting, deviation correction, counting and other functions.

型号规格与参数 Parameters

型 号 Item code	KS-C2R/G/W/B	KS-C2R/G/W/B-P	KS-C2GR/RW/GB/GW/WB/RB	KS-C2GR/RW/GB/GW/WB/RB-P
类 型 Type	聚焦型 Focus			
开关组成 Composition	发射器与接收器一体 Emitter and receiver in one housing			
检测距离 Sn	10±2mm			
输出方式 Output	NPN NO+NC	PNP NO+NC	NPN NO+NC	PNP NO+NC
光 源 Light source	单色可见红光/绿光/白光/蓝光 Monochromatic visible red / Green / White / blue		双色可见红光/绿光/白光/蓝光 Double color visible red / Green / White / blue	
电源电压 Supply voltage	10…30VDC			
光斑直径 Spot diameter	<1.5mm			
响应时间 Responses time	Max, 1ms			
迟滞范围 Hysteresis	1…15%			
重复误差 Repeatability	≤3%			
负荷电流 Load current	≤200mA			
残留电压 Residual voltage	≤2.5VDC			
消耗电流 Current consumption	≤45mA			
保护回路 Protection circuit	浪涌、短路、逆极性保护 Reverse polarity protection/ short-circuit protection/ surge protection			
输出指示 Output indicator	红色 LED Red LED			
环境温度 Ambient temperature	-25…55℃			
环境湿度 Ambient humidity	35-85%RH			
耐 电 压 Withstanding voltage	1000V/AC 50/60Hz 60s			
绝缘阻抗 Insulation resistance	≥50MΩ (500VDC)			
耐 振 动 Anti-vibration	复振幅1.5mm 10…50Hz (X, Y, Z方向各2小时) 10~50Hz, double-amplitude; 1.5mm(in each of x, y and z direction for 2 hours)			
防护等级 Protection degree	IP65			
外壳材料 Housing material	PBT			
接线方式 Connection	2m PVC 电缆 2m PVC cable			

尺寸图 Dimensions

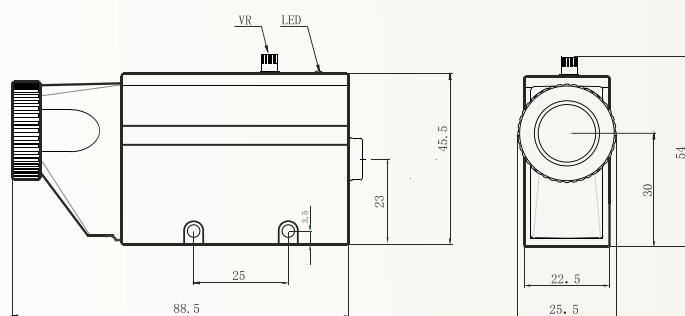

电气接线图 Electrical wiring diagram

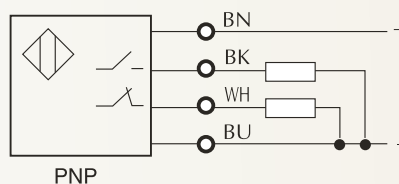
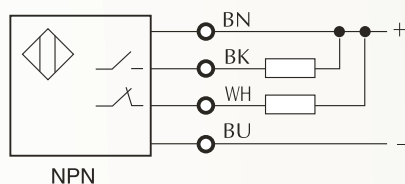

型号规格与参数 Parameters

型号 Item code	Z3N-TR2/TG2/TB2/TW2	Z3N-TR2/TG2/TB2/TW2-P	Z3N-TR22/TG22/T22/TB22/TW22	Z3N-TR22/TG22/T22/TB22/TW22-P
类型 Type	聚焦型 Focus			
开关组成 Composition	发射器与接收器一体 Emitter and receiver in one housing			
检测距离 Sn	10±2mm			
输出方式 Output	NPN 三芯 NPN three core	PNP 三芯 PNP three core	NPN 四芯 NPN four core	PNP 四芯 PNP four core
光源 Light source	可见红、绿、红绿、绿蓝、绿白光 Visible red, green, blue, red and green, blue and White		可见红、绿、红绿、绿蓝、绿白光 Visible red, green, blue, red and green, blue and White	
电源电压 Supply voltage	10…30VDC			
光斑直径 Spot diameter	<1.5mm			
响应时间 Responses time	Max, 1ms			
迟滞范围 Hysteresis	1…15%			
重复误差 Repeatability	≤3%			
负荷电流 Load current	≤200mA			
残留电压 Residual voltage	≤2.5VDC			
消耗电流 Current consumption	≤45mA			
保护回路 Protection circuit	浪涌、短路、逆极性保护 Reverse polarity protection/ short-circuit protection/ surge protection			
输出指示 Output indicator	红色 LED Red LED			
环境温度 Ambient temperature	-25…55℃			
环境湿度 Ambient humidity	35-85%RH			
耐电压 Withstanding voltage	1000V/AC 50/60Hz 60s			
绝缘阻抗 Insulation resistance	≥50MΩ (500VDC)			
耐振动 Anti-vibration	复振幅1.5mm 10…50Hz (X, Y, Z方向各2小时) 10~50Hz, double-amplitude; 1.5mm(in each of x, y and z direction for 2 hours)			
防护等级 Protection degree	IP65			
外壳材料 Housing material	金属(锌合金) Metal(ZN Alloy)			
接线方式 Connection	2m PVC 电缆 2m PVC cable			

尺寸图 Dimensions

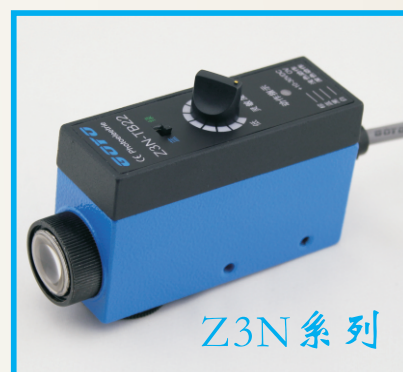
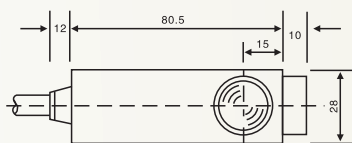
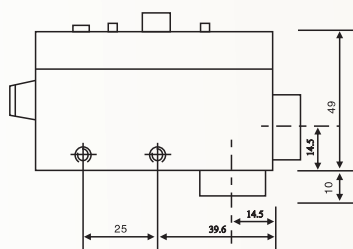

电气接线图 Electrical wiring diagram

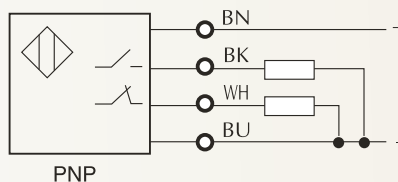
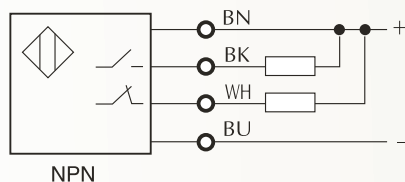

BK: 浅色动作
Light movement

WH: 深色动作
Dark movement

型号规格与参数 Parameters

型号 Item code	BZJ-311G/W/B	BZJ-312GR	BZJ-313
类型 Type	聚焦型 Focus		
开关组成 Composition	发射器与接收器一体 Emitter and receiver in one housing		
检测距离 Sn	12±2mm		
输出方式 Output	NPN/PNP	NPN/PNP	NPN/PNP
光源 Light source	单色可见绿光/白光/蓝光 Monochromatic visible Green / White / blue	双色可见红光/绿光 Double color visible red / Green	可见红光/绿光/蓝光, 自动选择 Visible red / Green / blue, automatic selection
电源电压 Supply voltage	10~30VDC		
光斑直径 Spot diameter	<1.5mm		
响应时间 Responses time	≤50 μs		
迟滞范围 Hysteresis	1~15%		
重复误差 Repeatability	≤3%		
负荷电流 Load current	≤200mA		
残留电压 Residual voltage	≤2.5VDC		
消耗电流 Current consumption	≤45mA		
保护回路 Protection circuit	浪涌、短路、逆极性保护 Reverse polarity protection/ short-circuit protection/ surge protection		
输出指示 Output indicator	红色 LED Red LED		
环境温度 Ambient temperature	-25~55℃		
环境湿度 Ambient humidity	35~85%RH		
耐电压 Withstanding voltage	1000V/AC 50/60Hz 60s		
绝缘阻抗 Insulation resistance	≥50MΩ (500VDC)		
耐振动 Anti-vibration	复振幅1.5mm 10~50Hz (X, Y, Z方向各2小时) 10~50Hz, double-amplitude; 1.5mm(in each of x, y and z direction for 2 hours)		
防护等级 Protection degree	IP65		
外壳材料 Housing material	金属(锌合金) Metal(ZN Alloy)		
接线方式 Connection	2M PVC电缆或M12接插件 2M PVC cable or M12 connector		

尺寸图 Dimensions

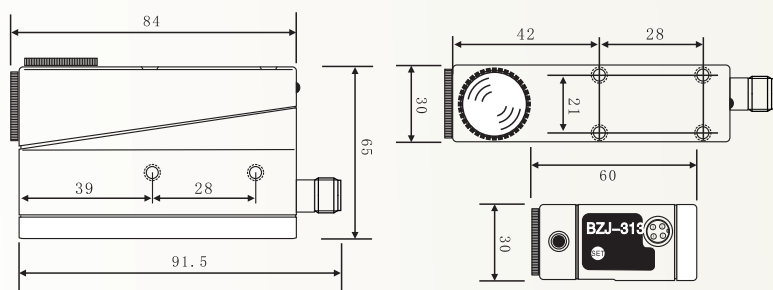

BZJ 系列

电气接线图 Electrical wiring diagram

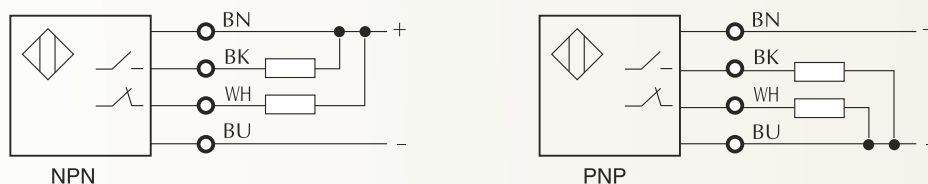



WWW.CHGOYO.COM

服务热线：400-882-0577

温州市光洋工业自动化有限公司

Wenzhou Guangyang Industrial Automation CO., LTD.

地址：浙江省乐清市柳市镇东风工业区凌云路20号6楼

邮编：325604

电话：86-0577-27868888

传真：86-0577-27867788

邮箱：chgoyo@126.com

Add:NO.20,Lingyun Road, Dongfeng Industrial Zone,Liu shi town, Yueqing City, Zhejiang Province, China 325604

Tel: 86-577-27868888

Fax: 86-577-27867788

E-mail:chgoyo@126.com